

KF/ISO FITTINGS

ISO components (flange system designed in accordance with ISO-International Standards Organization) are an economical, convenient and simplified means of constructing custom vacuum systems. The system consists of two identical 360 degree rotatable flanges, a centering ring which supports the elastomer O-ring and a quick acting clamp which compresses the sealing ring between the two flanges.

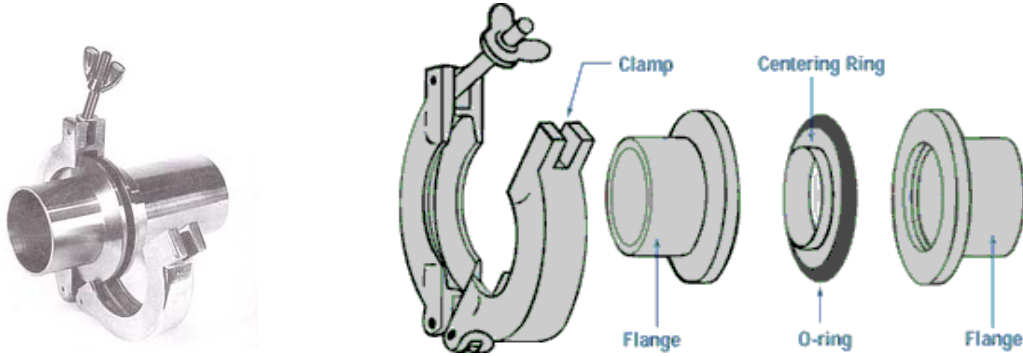

SWING CLAMP (ALUMINUM) W/ WING NIT



SIZE	PART#
KF 10 & 16	90512403
KF 25	90514403
KF 40	90516403
KF 50	90517403

Centering Ring Assembly (W/ O-Ring)



SIZE	w/ screen	w/o screen
KF 10	N/A	9051136
KF 16	DY-KF16M3CRNS	90512396
KF 25	DY-KF25M3CRNS	90514396
KF 40	DY-KF40M3CRNS	90516396
KF 50	DY-KF50M3CRNS	90517396

KF/ISO FITTINGS

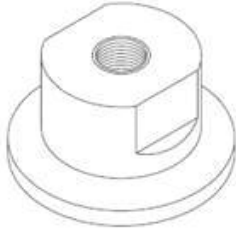

Adapter, KF to NPT (Female)

SIZE	PART#	MATERIAL
KF 16 to 1/8"	DY-KF16FNPT3	304sst
KF 16 to 1/4"	DY-KF16FNPT6	304sst
KF 25 to 1/8"	DY-KF25FNPT3	Aluminum
KF 25 to 1/4"	DY-KF25FNPT6	Aluminum
KF 25 to 1"	US25100	Aluminum
KF 40 to 1/8"	DY-KF40FNPT3	304sst
KF 40 to 1/4"	DY-KF40FNPT6	304sst
KF 50 to 1/8"	DY-KF50FNPT3	304sst
KF 50 to 1/4"	DY-KF50FNPT6	304sst



Adapter, KF to NPT (Male)

SIZE	PART#	MATERIAL
KF 16 to 1/8"	DY-KF16MNPT3	304SST
KF 16 to 1/4"	DY-KF16MNPT6	304SST
KF 25 to 1/8"	DY-KF25MNPT3	304SST
KF 25 to 1/4"	DY-KF25MNPT6	304SST
KF 25 to 1/2"	DY-KF25MNPT13	304SST
KF 25 to 3/4"	DY-KF25MNPT19	304SST
KF 40 to 1/4"	DY-KF40MNPT6	304SST
KF 40 to 1/2"	DY-KF40MNPT13	304SST
KF 40 to 3/4"	DY-KF40MNPT19	304SST
KF 40 to 1"	DY-KF40MNPT25	304SST

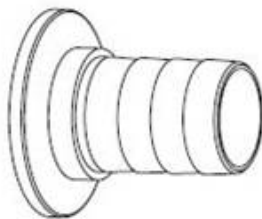

Hose Adapter, KF to PVC Hose

SIZE	PART#	MATERIAL
KF 10 to 1/2" ID Hose	10504081	304sst
KF 16 to 1/2" ID Hose	10504104	304sst
KF 25 to 1" ID Hose	10504225	304sst
KF 40 to 1-1/2" Hose	10504326	304sst
KF 40 to 2" ID Hose	10504352	304sst

KF/ISO FITTINGS

OTHER FITTINGS AVAILABLE

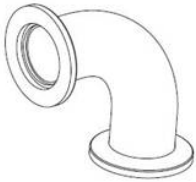

90 ELBOW

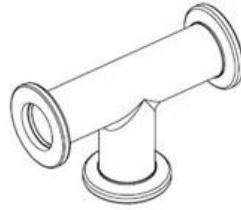

TEE

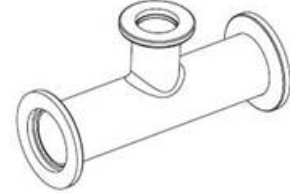

REDUCING TEE



CROSS



CONICAL REDUCER

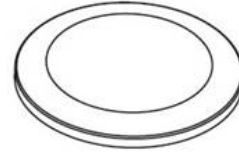

BLANK-OFF FLANGE

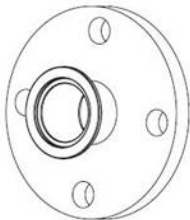

ANSI x KF Flange

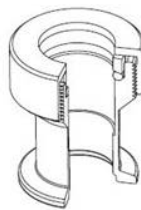

Hose quick connect



SCREENED RING



COMPRESSION BELLOWS



FLEXIBLE BRAIDED HOSE