

LVT SERIES

LIQUID RING VACUUM PUMPS

Models LVT 200, 300

INSTALLATION
OPERATION
MAINTENANCE

MANUAL



WARNING

**DO NOT OPERATE BEFORE
READING MANUAL**



US VACUUM PUMPS LLC

P.O. BOX 909
CANTON, TX USA 75103
TEL: 888-416-7366 FX: 877-416-7599
EMAIL: USVACUUM@EARTHLINK.NET
WWW.USVACUUMPUMPS.COM

FORWARD

This manual contains installation, operation, maintenance and troubleshooting information for the Model LVT-200 & LVT-300 Liquid Ring Vacuum Pumps. Please read it in its entirety before operating the pump.

Our Liquid Ring Vacuum Pumps are designed to ensure safety when used properly. It is the responsibility of the user to follow safety-related warnings, cautions, notes and other requirements described in this manual.

Returned equipment will not be accepted by our company without prior authorization. Prior to shipping please call for a returned goods authorization number (RGA).

Our company reserves the right to cancel the warranty if the pump is disassembled without authorization, if pump fluids are used that are not compatible with the design and materials used in the manufacturer of the pump, and if unauthorized spare parts are used.

SAFETY INSTRUCTIONS FOR LIQUID RING VACUUM PUMPS

Please read the following safety information on this page before operating your vacuum pump

- Do not operate the pump without the belt guard or coupling guard properly attached. Disconnect the pump from the electrical supply at the main before removing the guard. Replace the guard before reconnecting the power supply. Operating the pump without the guard secured in place exposes people in the vicinity of the pump to risk from rotating drive parts. Make sure the pump is completely reassembled, the belt guard is replaced, and all drain and fill valve and plugs are closed before reconnecting the power supply.
- Do not operate the pump with oxygen enriched gas in the suction line, where the proportion of oxygen exceeds 20%, unless the pump is using water as a sealant or an inert fluid suitable for the application. Pumping oxygen enriched gases with mineral oil or other non-inert fluids can cause an explosion in the pump, resulting in damage or injury.
- Take precaution to avoid prolonged or excessive exposure to oil mist or process materials from the discharge of the pump, or, prolonged or excessive exposure to oil mist from oil sealed pumps. Do not allow the pump to discharge into closed room, or a room without adequate ventilation. Always use a discharge oil mist eliminator for oil sealed systems. Venting the outlet of the pump or oil mist eliminator to the open air is highly recommended.
- Do not restrict the pump discharge line in any way, or place any valves in the discharge line. The vacuum pump is a compressor and will generate high pressures without the motor stalling when at low suction pressures. Excessive pressure build-up could cause damage or injury.
- Accidental starting or operation of the pump while maintenance is in progress may cause injury or damage
- Lift only with the frame mounted eyebolts.

WARNING

- THE BELTGUARD OR COUPLING GUARD MUST BE PROPERLY SECURED IN PLACE AT ALL TIMES WHILE THE PUMP IS RUNNING

CAUTION

- DO NOT OPERATE THE PUMP DRY
- MAKE SURE COOLING LIQUID IS AVAILABLE TO THE PUMP & SEALS
- DO NOT ALLOW SEALANT LIQUID TO FREEZE IN THE PUMP
- DISCHARGE PIPING SHOULD NOT EXCEED 24 INCHES ABOVE THE DISCHARGE FLANGE
- SUCTION MANIFOLD MUST BE FREE OF WELDING SLAG
- DO NOT START THE PUMP WITH SEALANT LEVEL ABOVE SHAFT CENTERLINE

TABLE OF CONTENTS

1. Safety Instructions.....	Page 2
2. General.....	Page 6
3. Introduction.....	Page 7
4. Specifications.....	Page 8
5. System Components.....	Page 9
6. Principle of Operation.....	Page 10
7. Seal Water Arrangements.....	Page 11
8. Properties of sealants.....	Page 12
9. Type of Sealant systems.....	Page 13
10. Operation.....	Page 14
11. Disassembly & Reassembly.....	Page 17
12. Trouble shooting Chart.....	Page 19
13. Sectional Drawings & Parts List.....	Page 1

US Vacuum Pumps LLC

CONGRATULATIONS on your purchase of a new Liquid ring Vacuum Pump from US VACUUM. Please examine the pump for shipping damage, and if any damage is found, report it immediately to the carrier. If the pump is to be installed at a later date make sure it is stored in a Clean, dry location and rotated regularly. Make sure covers are kept on all openings. If pump is stored outdoors be sure to protect it from weather and corrosion.

LVT vacuum pumps are built to exacting standards and if properly installed and maintained will provide many years of reliable service. We urge you to take time to read and follow every step of these instructions when installing & maintaining your pump.

WARNING: Serious injury can result from operating or repairing this machine without first reading the service manual and taking adequate safety precautions.

IMPORTANT: Record the pump model and serial number in the OPERATING DATA form below. You will save time and expense by including this reference information on any replacement parts orders.

OPERATING DATA

It is to the user's advantage to have the requested data filled in below and available in the event a problem should develop in the vacuum pump. This information is also helpful when ordering spare parts.

Model No. _____	Sealing Fluid _____
Serial No. _____	Operating Vacuum _____
Startup Date _____	Inlet Gas Composition _____
Motor Hp _____ Hp _____	Accessories supplied _____

NOTES: _____

GENERAL

UNPACKING

Inspect the box and pump carefully for any signs of damage incurred in transit and report with-in 7 days of receipt. Since all our pumps are shipped F.O.B. our factory, such damage is the responsibility of the carrier and reported to them. The inlet & exhaust of the pumps are covered with plastic caps to prevent dirt and other foreign substances from entering the pump. Leave the caps in place until you are ready to pipe the pump to your equipment.

The pumps are tested and preserved with a water soluble preservative prior to shipment. As the pump cannot be completely drained, some of the preservative remains in the pump when shipped. This solution should be flushed from the pump if it is to be used on a closed system where other than water is used.

LOCATION

Install the pump in a horizontal position on a level surface so that the pump is evenly supported on it's steel baseplate. Leave 12-18" of access around the pump to allow proper access for maintenance. If the unit is provided as an AIR-COOLED system, allow for proper air circulation around the radiator.

When selecting a location for the pump one consideration should be that the pump liquid must not be allowed to freeze.

POWER REQUIREMENTS

A schematic diagram for the electric motor terminal box is located either inside the junction box cover (3 phase) or on the side of the motor itself (1 phase). The motor must be connected according to applicable electrical codes through a fused switch in order to protect the motor against electrical or mechanical overload conditions. The overload of the motor starter must be set at a level equal to the full load motor current listed on the nameplate.

After the motor starter and disconnect switch have been installed, turn the pump by hand and determine that the impeller is free to turn and then momentarily start the motor to check direction of rotation. The direction of the pump must rotate as indicated by the arrows on the drive and casing. If the pump rotates in the wrong direction, have an electrician reverse any two of the motor leads.

WARNING: DISCONNECT PUMP FROM SOURCE OF ELECTRICAL POWER PRIOR TO MAKING REPAIRS OR ADJUSTMENTS TO ANY COMPONENT OF THE UNIT

VACUUM CONNECTION

Use a pipe size that is at least the size of the pump inlet connections. Smaller lines result in reduced pump capacity.

Pumps operating in parallel on a common main line should have a manual or automatic shut-off valve or positive acting check valve installed in the suction line of the pump.

Should the process gas contain dust or other foreign material, a suitable inline particulate filter should be connected to the inlet port.....contact U.S. Vacuum for recommendations.

The vacuum piping should be designed to insure that no liquids such as condensate or liquid carryover from the process can reach the pump. If this possibility exists, a knock-out liquid separator should be installed.....contact U.S. Vacuum for recommendations.

If an exhaust manifold is used, install a drip leg near the pump exhaust port and drain to prevent exhaust condensate from entering the pump exhaust box.

INTRODUCTION

Models covered by this manual

This manual contains installation and maintenance procedures for the LRV 15 to LRV 150 Close Coupled pumps. The nameplate on the pump provides a letter coding for pump material of construction.

Nameplate Data

Example: LRV 35-C/FB

The first letters LRV designate **L**iquid **R**ing **V**alve vacuum pump.

The number designation represents nominal pumping capacity in CFM at 60Hz operation (example 35 cfm).

C represents that the pump is a Close Coupled unit.

The letters after the pumping capacity represents the pump material of construction. The first letter represents the casing & endplate construction with the second letter representing the impeller construction.

F = Cast Iron

B = Bronze

S= Stainless steel (316)

Example: LRV 35-C/FB = Liquid Ring Valve Pump; 35 cfm, Closed-Coupled Design with Cast Iron casing and Bronze Impeller

Suitable Applications

U.S. Vacuum Liquid Ring Vacuum Pumps Models LRV are reliable non-pulsating pumps. LRV are Single -stage Configuration, suitable for operation down to 30 Torr absolute (approx. 29 inches Hg vacuum reference 30 inch barometer), when sealed with 60 Deg F. water.

IEC Motor wiring Diagram

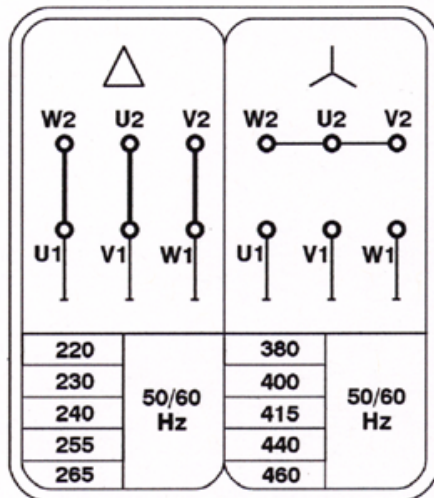

Specifications

Model	LVT	200	300
Speed	RPM	1750	1750
Drive		Direct	
Standard Motor	Hp	15	20
3/60/230-460V	kw	11	15
Sealant Liquid required (@60 deg F)	GPM	6	8
NO recovery	l/m		
Sealant Liquid required (@60 deg F)	GPM	3	4
Partial recovery	l/m		
Sealant Liquid connections	NPT	1/2	1/2
Inlet/Outlet	inches	2.5	2.5
Length	inches	24.5	27
Width	inches	12.5	12.5
Height	inches	19	19
Weight	lbs	293	321



US VACUUM PUMPS LLC

LVT-200 & LVT-300

BARE SHAFT CONSTRUCTION W/ MECHANICAL SEAL



U.S. VACUUM LVT pumps are single stage liquid ring vacuum pumps capable of producing a vacuum to 29" Hg . The pumps are available in various materials of construction (FB = Iron/Bronze, FS = Iron/Stainless steel, SS = All stainless steel).

Pumps are provided with threaded connections for service liquid, pump draining, vacuum relief valve and companion flanges. Optional items include inlet check valve, vacuum relief valve, flow control, solenoid valve, vacuum and temperature gauges.

Pumps can also come as completely packaged units using water or water as a seal fluid.

TECHNICAL DATA

PUMP TYPE		LVT 200	LVT 300
Pumping Capacity (@26" Hg)	CFM	180	275
Speed	RPM	1750	1750
Motor-Installed power	HP	15	20
Average service liquid flow	GPM	7	9
Noise level at 100 Torr	db(A)	73	73
Minimum suction pressure	Torr	25	25

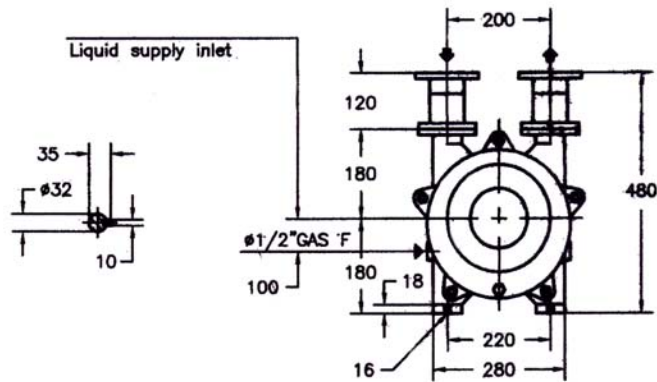
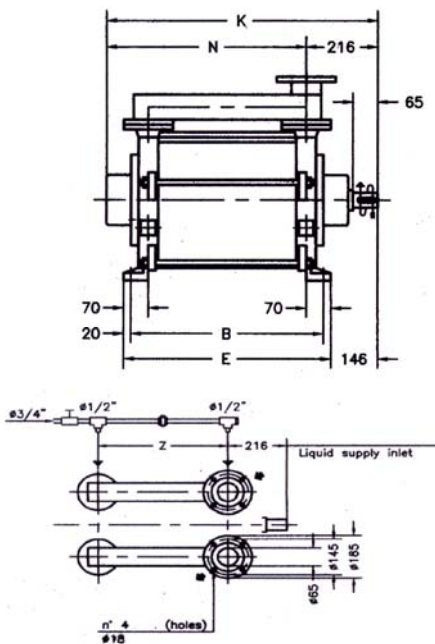

Pump Type	B	E	K	N	Weight
LVT 200	354	394	614	398	298
LVT 300	424	464	684	468	321

NOTE: Dimensions in mm
(1" = 25.4 mm)

DATA BASED ON :
 DRY AIR AT 68 °F - 20 °C
 SATURATED AIR AT 68 °F - 20 °C
 SERVICE LIQUID WATER
 SERVICE LIQUID TEMPERATURE 59 °F - 15 °C
 DISCHARGE PRESSURE 1013 mbar

S.S. PUMPS
 CAPACITY : -10%

PERFORMANCE DATA
 LIQUID RING VACUUM PUMP
 PUMP MODEL
LVT 200

Tol.: 10%

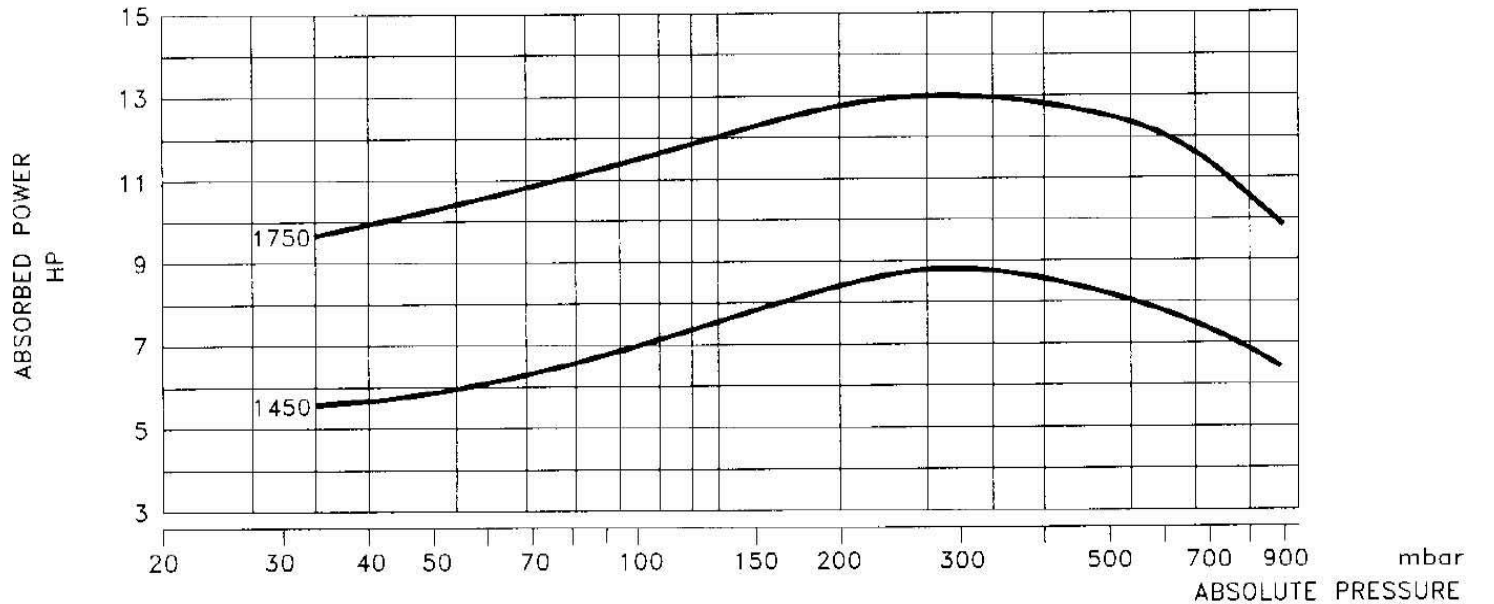
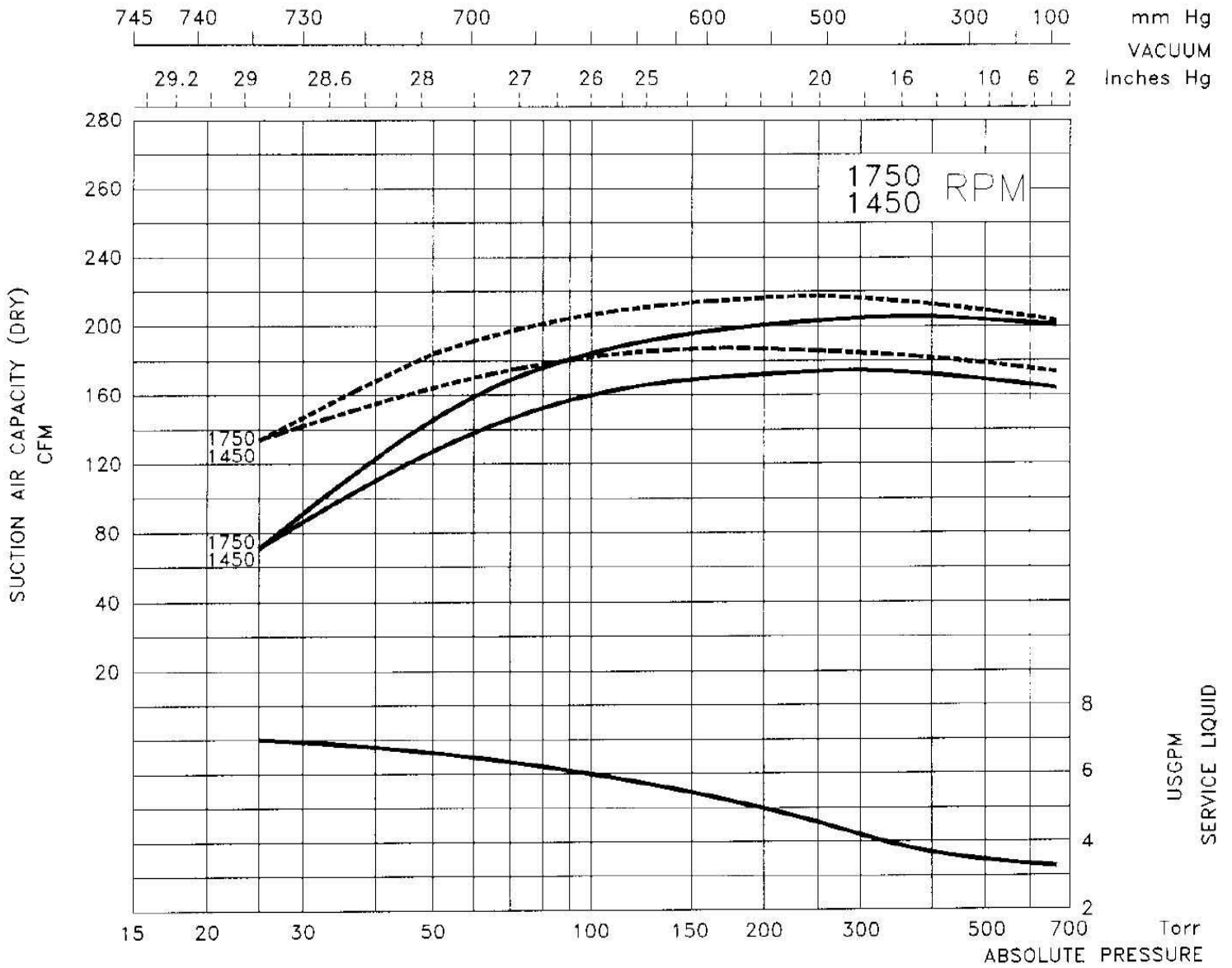

DATA BASED ON :

DRY AIR AT 68 °F - 20 °C
 SATURATED AIR AT 68 °F - 20 °C
 SERVICE LIQUID WATER
 SERVICE LIQUID TEMPERATURE 59 °F - 15 °C
 DISCHARGE PRESSURE 1013 mbar

S.S. PUMPS
 CAPACITY : -10%

Tol.: 10%

PERFORMANCE DATA
 LIQUID RING VACUUM PUMP
 PUMP MODEL
LVT 300

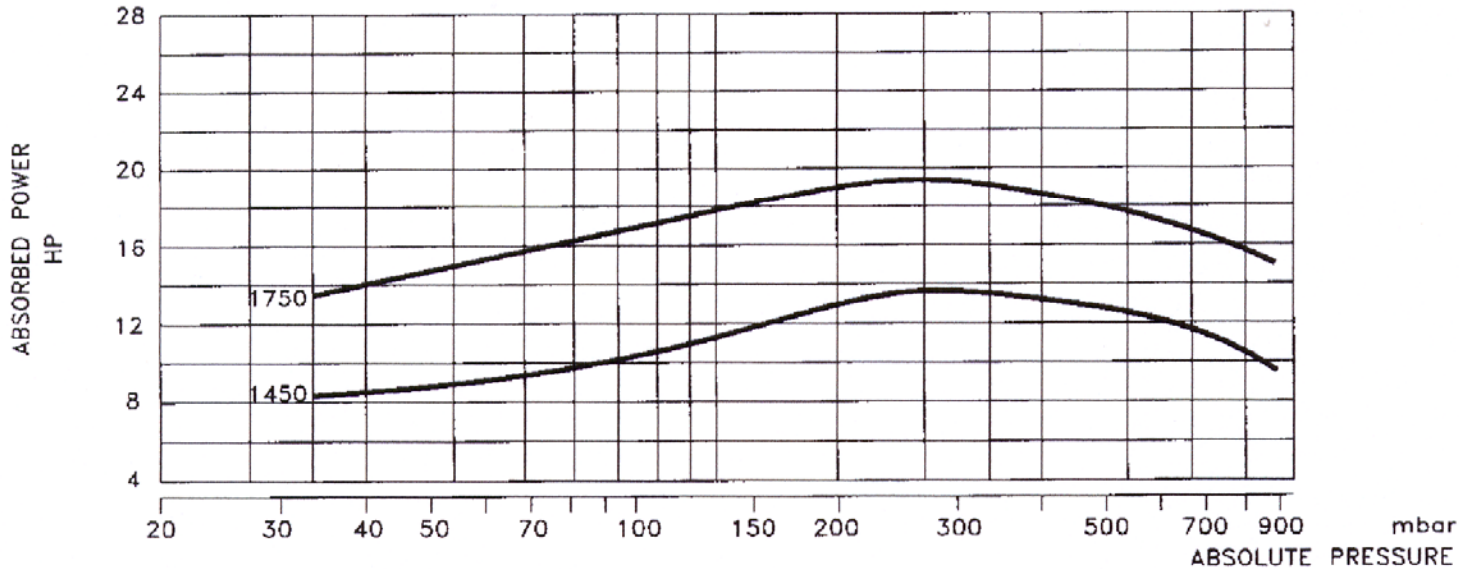
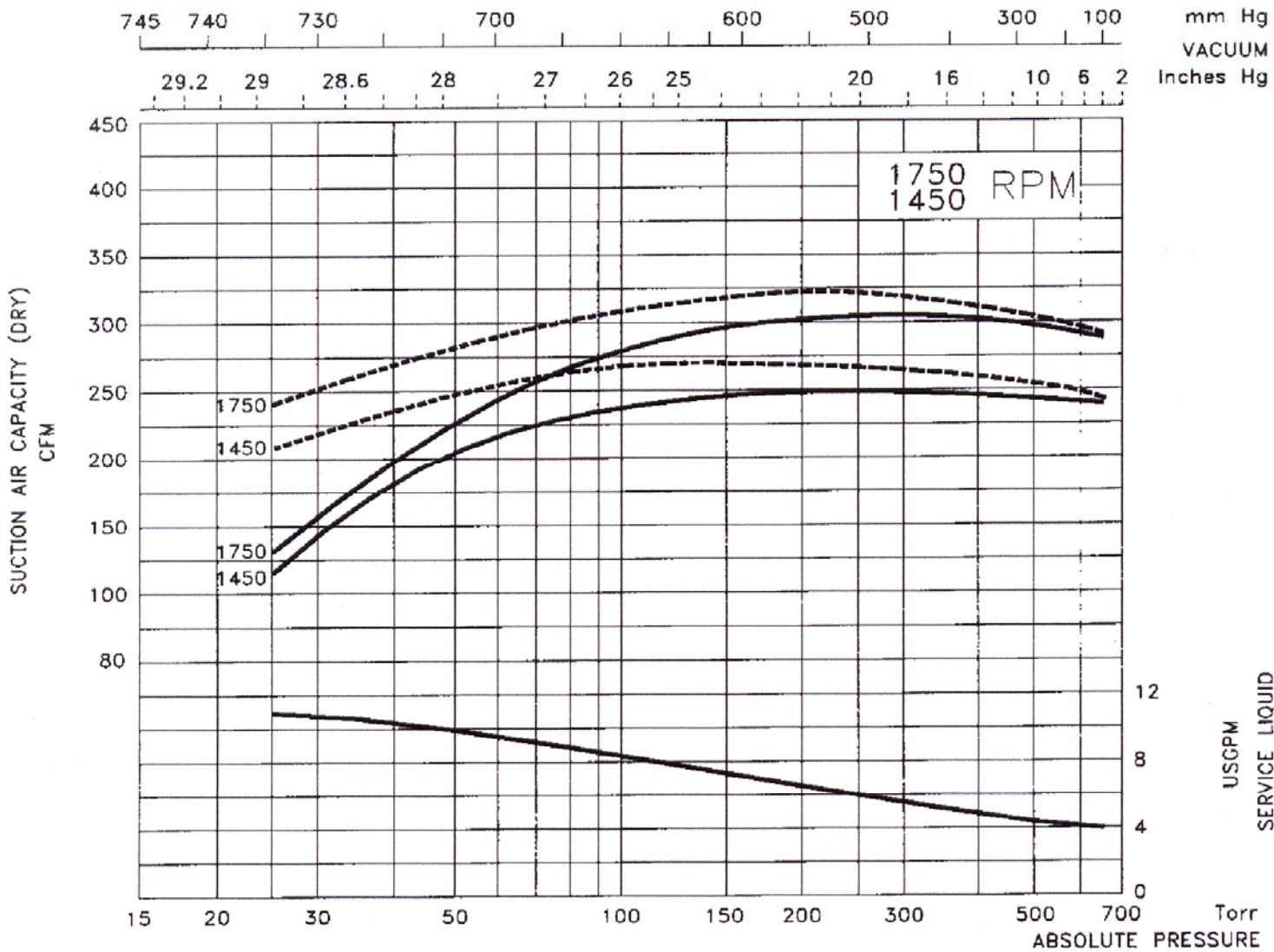

System Components

The following are some of the components available for installation either when the pump is ordered, or later to be installed in the field.

Inlet elbow: Used to adapt vertical pump inlet to horizontal for mounting inlet check valve, etc. A similar elbow may be used to connect the discharge separator tank.

Inlet vacuum gauge: Used to measure pump inlet vacuum. Standard 2-1/2" and optional 4" dial gauge has brass bourdon tube and reads 0-30" Hg. The gauge is mounted on the pump suction. Stainless steel vacuum gauges are available at additional cost.

Inlet check valve: Used to automatically isolate the pump from the process chamber when the vacuum pump is shut down, by blocking the backflow of air and sealant. Valve must be mounted in a horizontal position.

Inlet vacuum relief valve: Used to control pump inlet vacuum. If pump capacity exceeds the system requirements at present vacuum, then the valve open and admit ambient air. Valve selection is dependant upon desired vacuum setting and pump size.

Flexible connector: Used to accommodate some motion and misalignment between pump and system.

Inlet shut off valve: Used to positively isolate pump from process chamber. Ball valves are supplies up to 2" NPT. Butterfly valves are supplied for connections larger than 3"

Sealant solenoid valve: Used to establish sealant flow when motor is energized and return to closed position when motor is de-energized. Also prevents flooding the pump with sealant when pump is off.

Flow controller: Used to establish sealant flow rates to the vacuum pump.

Sealant circulation pump: Used to circulate recovered sealant. Required for use when operation at high pressure such as frequent cycling or when operating for prolonged periods above 400 Torr.

Strainer: Used to filter solid particles from the sealant

Heat exchanger: Used to cool circulated sealant.

PRINCIPLE OF OPERATION

US Vacuum Pumps LVT series Liquid ring Vacuum Pumps are durable Two Stage pumps having vacuum capabilities to approximately 28.9" Hg.

When the pump is operating, a continuous flow of seal liquid is entering the pump and forms a seal between the impeller and casing. The impeller is offset above center of the pump casing and as the impeller rotates, pumping action begins in the space between the impeller & pump casing by filling and emptying similar to a reciprocating compressor. Gas inlet and discharge ports are positioned so as to draw gas into the cavity inside the liquid sealed ring during the expansion segment and discharges gas along with some liquid during the compression segment. The discharged liquid can be recovered and re-circulated through the use of a gas/liquid separator.

Water is normally used as the liquid seal but may be unsuitable for some pump applications. Other commonly used fluids are oil, glycol and solvents.

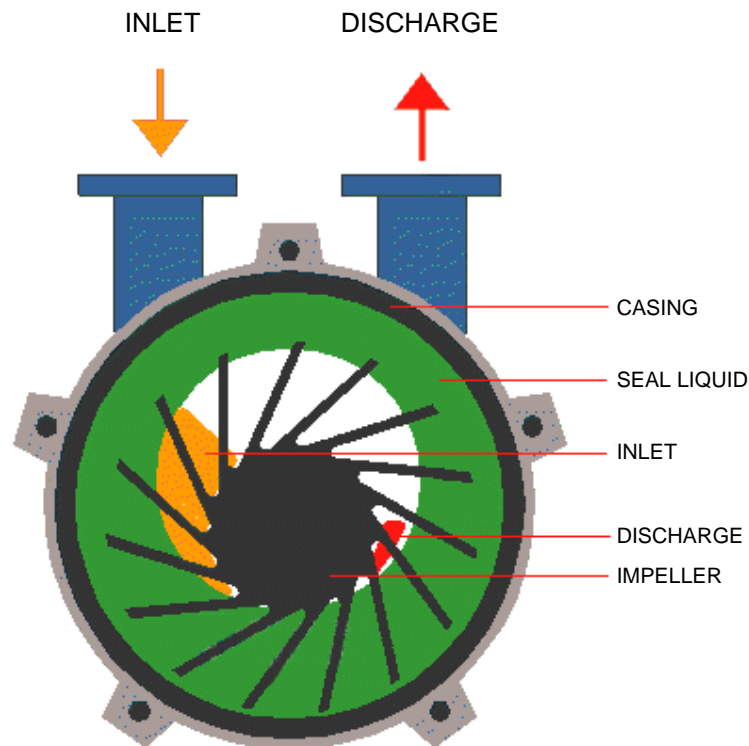

SEALING WATER ARRANGEMENTS

There are three (3) sealing liquid arrangements as shown in figure 2,3,4 based upon the amount of sealing water recovered and recirculated. The water available at the pump site may contain minerals which when used as a seal water will cause an undesirable scale to form inside the pump. This should be a consideration In selecting the most satisfactory arrangement, as any pump size and model can have any one of the three arrangements (Figures 2,3,4).





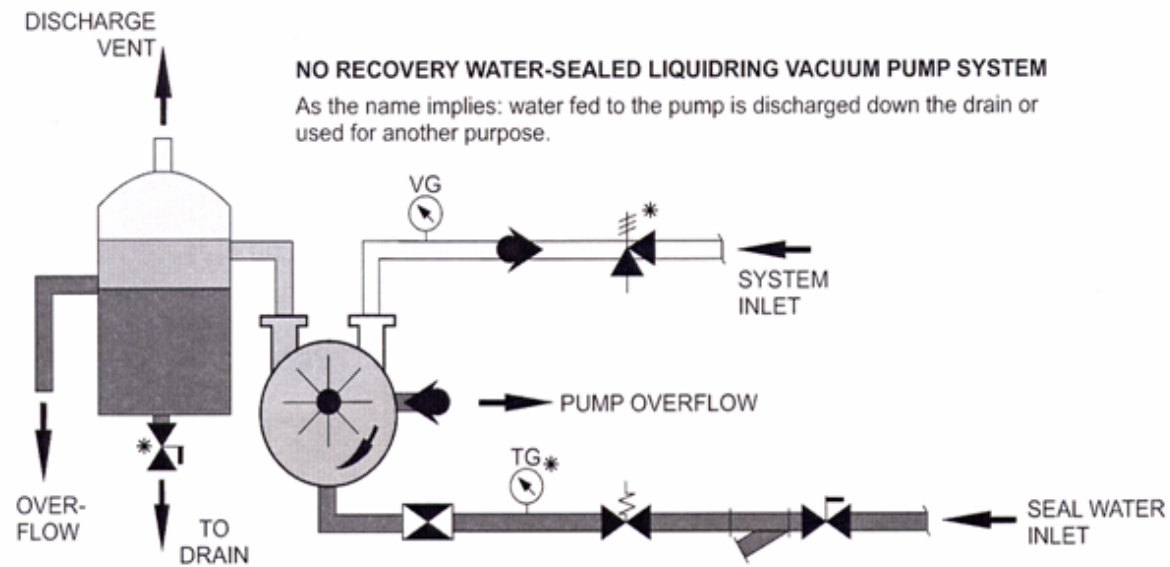









CAUTION:

- The pump must not run dry.
- Never start the pump with liquid level above the shaft line



Note: schematics are not binding.

FIGURE 2

	CHECK VALVE	TG	TEMPERATURE GAUGE	*	OPTIONAL
	FLOW CONTROL	CG	COMPOUND GAUGE		COOLING WATER
	GLOBE VALVE	VG	VACUUM GAUGE		AIR OR GAS
	SHUT-OFF VALVE				MIXTURE GAS/SEAL FLUID
	SOLENOID VALVE		STRAINER		SEAL FLUID
	VACUUM RELIEF VALVE		LEVEL SWITCH		RECIRCULATING PUMP
					HEAT EXCHANGER

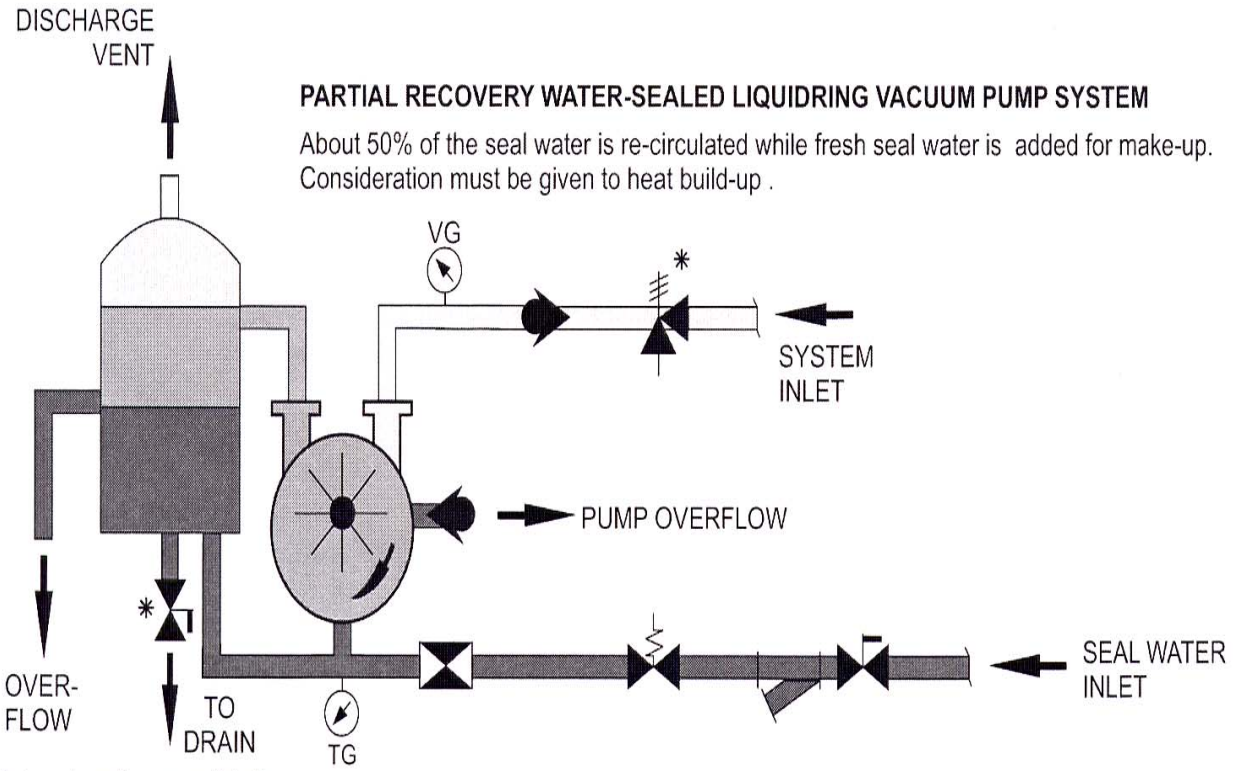
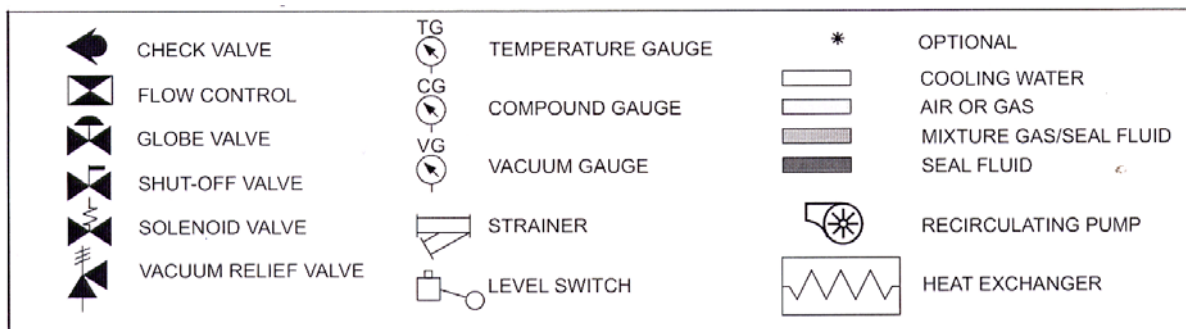

FIGURE 3



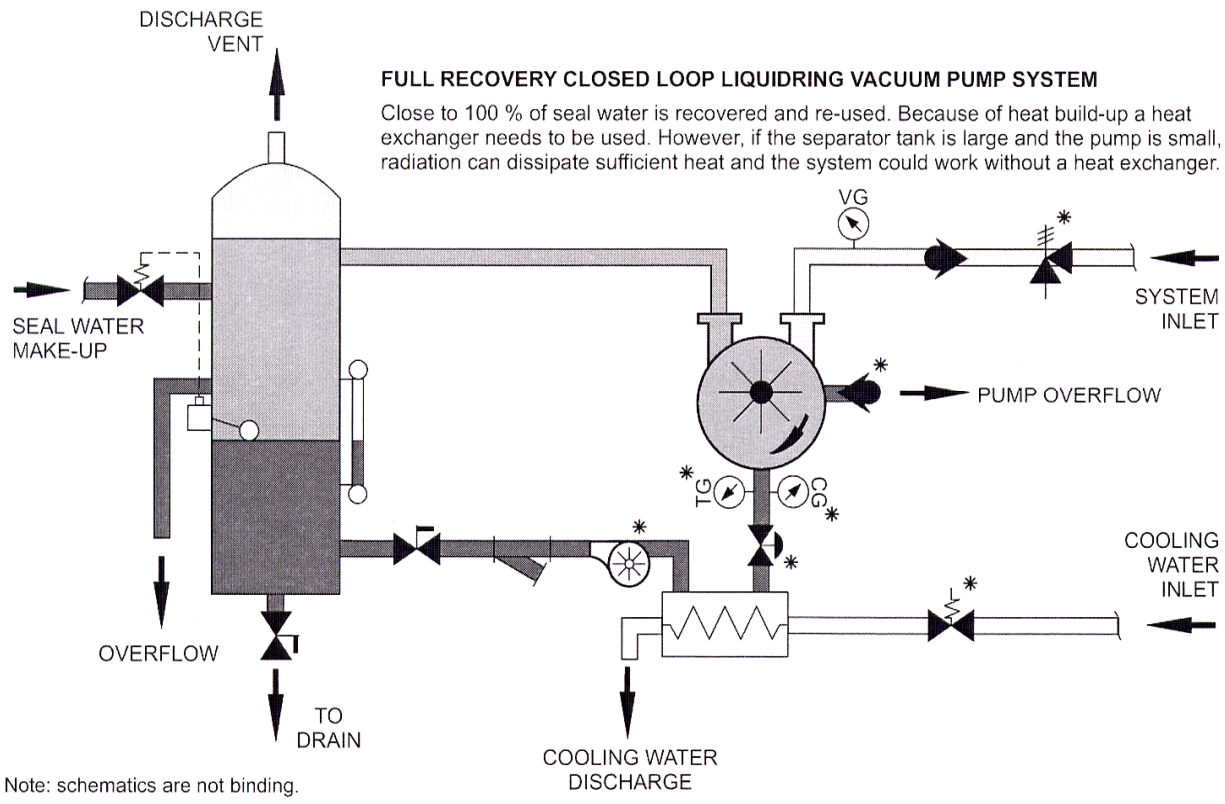
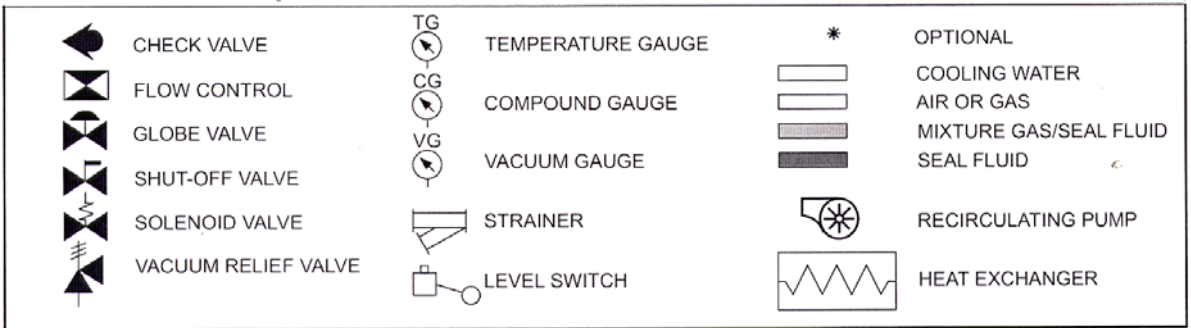

FIGURE 4



Properties of sealants

Water is the most commonly used sealant in liquid ring vacuum pumps. Other fluids may be used to obtain process compatibility. In these applications special consideration should be given to the properties of the sealant, which may affect pump performance. Some of the properties of sealant, which should be considered are:

- Specific gravity
- Specific heat
- Viscosity
- Vapor Pressure

Additionally, the solubility of process gas in the sealant can be of significance and should be evaluated especially if the partial or full recovery system is used. When water is the sealant its chemical content should be evaluated since certain conditions will affect the service life of the pump. Generally if water is suitable to drink it is suitable for pump use. Hardness greater than 500 PPM will result in internal plating and fouling of pump parts. Service with hardness of less than 500 PPM depends on operating temperature and the nature of the salt deposit. Naturally occurring well water with organic acid of pH-5 or higher is generally suitable, however pH of 7 or higher is preferred. Chemically treated water with sulfur content requires pH-7 or more. Water, which has a pH less than 5 should be treated, or the pump should have special materials of construction.

Sealant temperature

The rated capacity (ACFM) of LRH Liquid Ring vacuum pumps are based upon the use of incoming seal water of 60 Deg F. Seal water temperature affects the pump capacity. To calculate pumping capacity (ACFM) when using water at other than 60 Deg F the following formulas apply.

$$S_a = S_{60} \times \frac{(P_1 - P_c)}{(P_1 - 13.3)}$$

- Where: S_a = Actual capacity in ACFM at P_1
 S_{60} = Pump capacity with 60 Deg sealant at P_1 .
 P_1 = Inlet pressure in Torr
 P_c = Vapor pressure of sealant at actual sealant temperature

REFERENCE CHART

For calculating pumping Capacity of two –stage Liquid ring vacuum Pumps using various Seal water temperatures

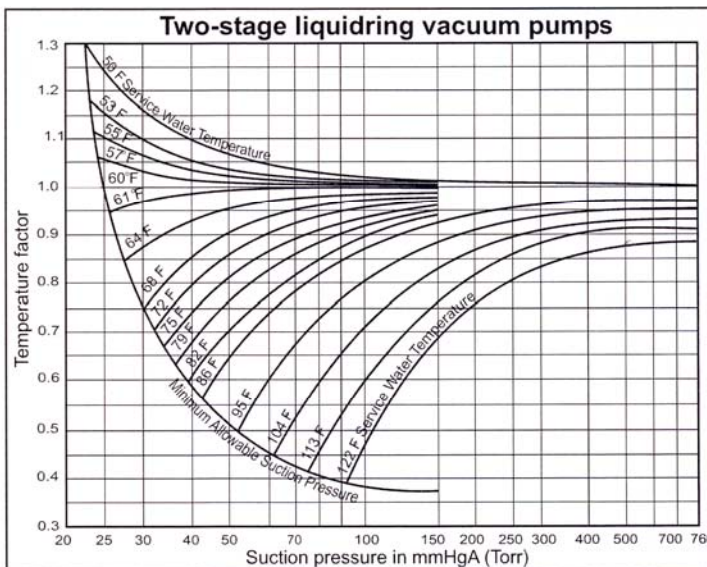

TYPE OF SEALANT SYSTEMS

NO SEALANT RECOVERY (Figure 2, page 11)

This arrangement takes water directly from the water main, circulates the water and discharges it through a separator tank to drain without re-circulation. This arrangement is most common on small pumps, in installations where water conservation is not a factor, or where contamination of sealant may be a problem

PARTIAL SEALANT RECOVERY (Figure 3, page 11)

This arrangement has the pump discharging water and gas into a gas/liquid separator tank where the gas-water mixture is separated, releasing the gas to atmosphere and retaining the water. Some water is disposed of through an overflow and the remainder is retained in the separator tank for re-circulation. A small continuous amount of sealant is added in quantity necessary to maintain the operating pressure.

This is the most commonly used arrangement where sealing liquid conservation is required.

FULL SEALANT RECOVERY (Figure 4, page 11)

This arrangement is similar to Partial Recovery, the difference being that incoming make-up sealant is controlled by a level switch on the recovery tank and a heat exchanger is added. The heat exchanger may be refrigerated water (shell & tube) or cooled air (Radiator). At pressures above 100 mm Hg, a circulation pump is installed to insure the proper amount of sealant is re-circulated.

Full recovery systems often operate under conditions where condensation will cause the liquid level to rise. The opposite condition can exist whereby liquid evaporation will make it necessary to add make-up liquid.

GENERAL

When installing a "No Sealant Recovery System", a drain connection may be installed as shown in figure 4, page 6 to drain liquid down to shaft level prior to starting the pump. Draining to shaft level may be necessary to avoid overloading the pump and motor when starting. Normally it is not necessary to drain to pump level prior to starting if during the prior pump shutdown the incoming sealant flow is stopped simultaneously while stopping the pump. An automatic solenoid valve (normally closed) is convenient for this use.

As the pump creates it's own vacuum it will draw in the required amount of seal water so that the seal water need will not be under pressure when pumping below 150 mm Hg.

If there is extensive piping fittings, valves and other restrictive devices in the seal line, the water would need to be adequately pressurized in order to overcome the pressure drop due to these fittings.

When operating, a fixed amount of seal water is being drawn into the pump. The pressure on the seal line will vary, depending upon the inlet pressure.

On a Full Recovery System which does not use a circulation pump, the seal water is drawn into the pump under pump suction entirely. For sustained operation above 150 mm Hg (abs), a circulation pump may be required.

OPERATION

SEALING LIQUID

The pump performance curves are determined by the temperature of the sealing liquid and influences the base pressure and pumping speed (capacity-cfm). At lower sealing liquid temperatures, the pump capacity increases and at higher temperatures the pump capacity decreases. The temperature/efficiency ratio is not linear and the most profound effect, in terms of percentage-of-change, is at low pump pressures.

Most pumps are recommended to utilize a water flow orifice which regulates the amount of water flow, if at least 15 PSI water pressure is supplied.

PROCEDURE FOR MINIMUM SEAL WATER REQUIREMENTS

The requirements for seal water as shown in our specifications are the maximum GPM for any application. To determine the minimum quantity of seal water required for a specific application proceed as follows:

Lower the pump suction pressure to between 50-150 mm Hg (abs). To steady the pressure with-in this range, bleed air into the suction of the pump and adjust this air until the pressure level remains constant within the range of 50-150 mm Hg. With the pressure level steady, slowly decrease the flow of seal water into the pump until the pressure begins to fluctuate and then gradually increase the flow until the pressure again becomes steady and this is the setting to allow the minimum seal water flow.

CAVITATION

Cavitation is recognized as a metallic noise in the pump when the pressure is low and the air flow is slight. When this occurs, slowly bleed air into the pump through the cavitation valve until the noise disappears. Bleeding air into the pump suction will also eliminate this noise, but a rise in pressure will occur.

STARTING THE PUMP

If the pump has been idle for an extended period of time, it is advisable to turn the pump over by hand prior to energizing the motor to determine that the impeller is free to turn. Some conditions to consider are (1) has the pump been idle for an extended period of time and not properly preserved, or (2) have repairs or alterations caused the piping to be disconnected thus the possibility of harmful objects entering the pump. If the shaft cannot be turned loosening the tie rods may free the impeller. Tighten the tie rods when impeller is free. Lightly tap the pump body with a soft faced hammer if scale build-up is obstructing the impeller.

The water level must be no higher than the pump shaft when starting the pump in order to prevent overloading the pump and motor. The cavitation valve is convenient for lowering the pump liquid to shaft level, however, this method may be too time consuming and if so, a drain cock should be provided on the seal water piping.

CAUTION

THE PUMP MUST NOT BE RUN DRY

STOPPING THE PUMP

- Isolate the pump from the system
- Shut off the seal water supply
- Stop the pump & bleed off excess water

MAINTENANCE

GENERAL

Elementary rules of cleanliness, periodic inspections, and a preventative maintenance policy of the pump will produce optimum performance and prolong the life of the pump.

SHAFT BEARINGS

The motor shaft bearing should be lubricated every 3000 hours of operation. Grease should be added through the Zirk while the shaft is turning. The temperature of the bearings should not exceed 140 Deg F....too much grease will cause the bearings to overheat. Some pumps are supplied without external grease fittings, these pumps have permanently packed bearings.

MECHANICAL SEALS

The pump comes with a single mechanical seal as a standard component with Viton elastomers. No seal adjustment is required.

STORAGE

If the pump is to be idle for an extended period of time, the interior must be preserved by circulating a water-soluble rust inhibitor through the pump with ports sealed. Rotate the pump by hand periodically.

TROUBLESHOOTING

CONDITION	CAUSE	REMEDY
Seals leaking	Seal incorrectly installed	Re-install seal
	Seal worn or damaged	Replace seal
Reduced capacity	Rotational speed too low	Check supply voltage
	Vacuum leak	Locate and repair
	High sealant temperature	Check coolant flow and temperature Check heat exchanger cleanliness
	Incorrect sealant flow rate	Adjust to correct flow rate
Excessive noise	Defective bearing	Replace
	Too much sealant liquid	Decrease flow rate
	Coupling misaligned	Align
	Cavitation	Open attenuation valve or reset vacuum relief valve to increase flow
Overheating	Defective bearing	Replace
	High sealant temperature	Check coolant flow and temperature
	Suction open to atmosphere	Adjust isolation valve
Excessive Vibration	Coupling misaligned	Align
	Pump not properly anchored	Anchor
	See excessive noise	Check inlet pressure & gas flow
Motor overloaded	Excessive back pressure	Reduce height of pump discharge
	Too much sealant liquid	Decrease flow rate
	Misalignment	Realign motor & pump
	Defective bearing	Replace bearing
Abnormal bearing wear	Misaligned pump assembly	Realign motor & pump
Impeller binding	Accumulation of rust or scale	De-scale or remove rust
	Foreign object in pump	Dismantle pump & remove object
Mechanical seals squeal	Insufficient cooling liquid	Increase coolant flow to seal

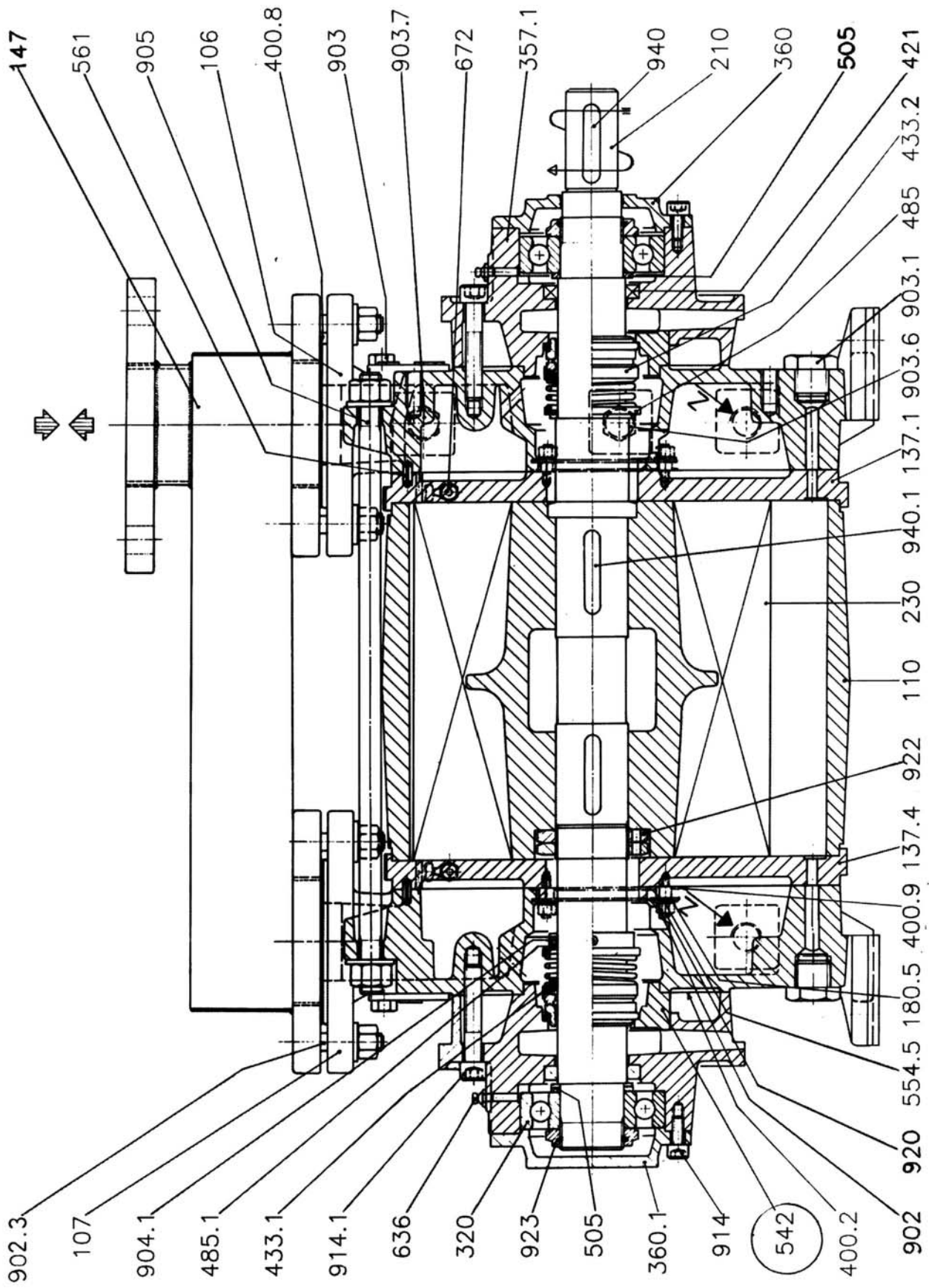

LVT200/300

LVT-300 PARTS LIST

ITEM #	QTY	DESCRIPTION	PART NUMBER	NET PRICE EA.
106	1	SUCTION COVER	305 61 100 060	
107	1	DISCHARGE COVER	305 61 110 060	
110	1	CENTER BODY	305 83 100 001	
137.1G	1	SIDE ELEMENT	ELE B2C 000 060	
137.4G	1	SIDE ELEMENT	ELE B2C 001 060	
147	2	MANIFOLD	305 80 100 030	
180.5	2	VALVES PLATE	045 19 100 066	
210.G	1	SHAFT ASSEMBLY	ALB B2C 103 041	
230	1	IMPELLER	305 640 200 060	
*320	2	BALL BEARING	961 006 308 000	
357.G	2	BEARING HOUSING	062 23 200 001	
360	1	BEARING COVER (D.E.)	001 081 101 001	
360.1	1	BEARING COVER (N.D.E.)	001 080 101 001	
*400.G	1	GASKET SET	GUA B2C 000 00M	
400.9	2	FLAT VALVE	945 900 681 613	
*421	2	LIP SEAL	942 043 600 603	
*433	2	MECH. SEAL (DE & NDE)	95B043BCC96H	
485	1	LOCATING RING NDE SEAL	013 19 100 032	
905	5	TIEBOLT	914 014 390 034	
922	1	IMPELLER NUT	031 48 100 041	
*923	2	BEARING NUT	920 040 015 075	
940	1	SHAFT KEY	930 050 108 034	
	2	IMPELLER KEY	930 050 160 041	

*C.F. CONSULT FACTORY

*RECOMMENDED SPARE PARTS

Liquid Ring Vacuum Pump Repair Kit:

Part Number: 1100-V065-F450

KIT CONTENTS		
Item Number	Qty	Description
*320	2	Bearings
*400.G	1	Gasket Set
*433	2	Mechanical Seal
*923	2	Bearing Nuts

Gasket set includes: All gaskets, lip seals,
flat valve gaskets, tube of gasket eliminator.

WARRANTY– VACUUM PRODUCTS

Subject to terms and conditions hereinafter set forth and set forth in General Terms of Sale, US Vacuum Pumps LLC (the seller) warrants products of its manufacturer, when shipped, and its work (including installation & start-up) when performed, will be of good quality and will be free from defects in material and workmanship. This warranty applies only to sellers equipment, under use and service in accordance with seller's written instructions, recommendations and ratings for installation, operating, maintenance and service of products for a period of 12 months. Because of varying conditions of installation and operation, all guarantees of performance are subject to plus or minus 5% variation.

THIS WARRANTY EXTENDS ONLY TO BUYER AND/OR ORIGINAL END USER, AND IN NO EVENT SHALL THE SELLER BE LIABLE FOR PROPERTY DAMAGE SUSTAINED BY A PERSON DESIGNATED BY THE LAW OF ANY JURISDICTION AS A THIRD PARTY BENEFICIARY OF THIS WARRANTY OR ANY OTHER WARRANTY HELD TO SURVIVE SELLER'S DISCLAIMER.

All accessories furnished by seller but manufactured by others (motor) will bear only that manufacturer's standard warranty.

All claims for defective products, parts, or work under this warranty must be made in writing immediately upon discovery and, in any event within one (1) year from date of shipment of the applicable item by seller. Unless done with prior written consent of seller, any repairs, alterations or disassembly of sellers equipment shall void warranty. Installation and transportation costs are not included and defective items must be held for seller's inspection and returned to sellers Ex-works point upon request.

THERE ARE NO WARRANTIES, EXPRESSED, IMPLIED OR STATUTORY WHICH EXTENDS BEYOND THE DESCRIPTION ON THE FACE HEREOF, INCLUDING WITHOUT LIMITATION, THE IMPLIED WARRANTIES OF MERCHANTABILITY AND FITNESS OF PURPOSE.

After buyers submission of a claim as provided above and its approval, seller shall at its option either repair or replace its product, part, or work at the original Ex-works point of shipment, or refund an equitable portion of the purchase price.

The products and parts sold hereunder are not warranted for operation with erosive or corrosive materials or those which may lead to a build-up of material within the product supplied, nor those which are incompatible with the materials of construction. The buyer shall have no claim whatsoever and no product or part shall be deemed to be defective by reason of failure to resist erosive or corrosive action nor for problems resulting from build-up of material within the unit nor for problems due to incompatibility with the materials of construction.

Any improper use, operation beyond capacity, substitution of parts not approved by seller, or any alteration or repairs by others in such manner as in sellers judgment affects the product materially and adversely shall void this warranty.

No employee or representative of seller other than an officer of US Vacuum Pumps LLC is authorized to change this warranty in any way or grant any other warranty. Any such change by an officer of the company must be in writing.

In no event shall buyer be entitled to incidental or consequential damages. Any action for breach of this agreement must commence within (1) year after the cause of action has occurred.

NOTES